

*ALLOW 6" CLEARANCE TO SERVICE BRAKE

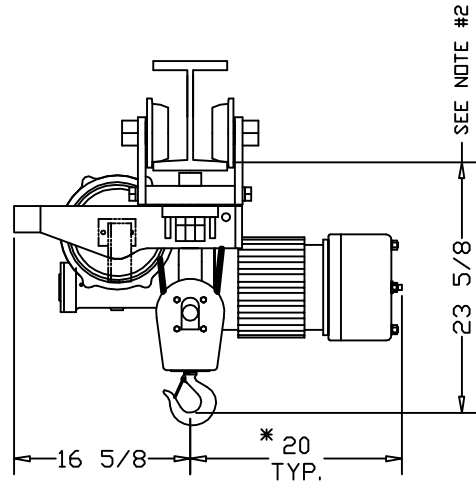

	CATALOG #			
	41-PL	-	-	-
SPEED (FPM):	20	-	-	-
LIFT (FT):	10	-	-	-
CAPACITY (LBS):	4000 LBS			
REEVING:	4 PART SINGLE			
PRIMARY VOLTAGE:	460 or 230 (3 PH. STD)			
CONTROL VOLTAGE:	115 (STD)			
HOIST WEIGHT (LBS):	520			
HP:	4			
WHEEL LOADINGS (LBS PER WHEEL PAIR):				
FULL UP		FULL DOWN		
LEFT SIDE	RIGHT SIDE	LEFT SIDE	RIGHT SIDE	
980	3540	1320	3200	
HOOKBLOCK DRIFT AT FULL DOWN POSITION (IN.) (X): 2-1/8				
HOIST NOTES:				
1. LARGER CONTROL BOXES MAY NEED TO BE RELOCATED				
2. PATENTED TRACK = 24-1/8"				

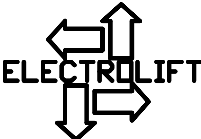

ELECTROLIFT, INC.
204 SARGEANT AVE.
CLIFTON, NJ 07013
PH: 973-471-0204
FAX: 973-471-2814
www.electrolift.com

REV.	ECO#	DATE	BY:

HOIST TYPE: "B" SINGLE HOOK

CONFIGURATION: PLAIN TROLLEY

DATE:	SCALE:	DWG SIZE:	DRAWN BY:
6/22/04	1:12	B	AR

CATALOG NO.:	DRAWING NO.:
41-PL	B-120

CUSTOMER:

REFERENCE NO.:

ELECTROLIFT AUTHORIZED DISTRIBUTOR: