

*ALLOW 6" CLEARANCE TO SERVICE BRAKE

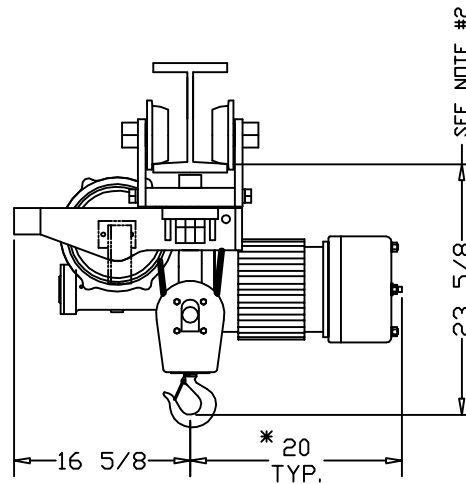

	CATALOG #			
	36-PL	-	-	-
SPEED (FPM):	20	-	-	-
LIFT (FT):	29	-	-	-
CAPACITY (LBS):	4000 LBS			
REEVING:	4 PART SINGLE			
PRIMARY VOLTAGE:	460 or 230 (3 PH. STD)			
CONTROL VOLTAGE:	115 (STD)			
HOIST WEIGHT (LBS):	595			
HP:	4			
WHEEL LOADINGS (LBS PER WHEEL PAIR):				
	FULL UP		FULL DOWN	
	LEFT SIDE	RIGHT SIDE	LEFT SIDE	RIGHT SIDE
	876	3719	1946	2649
HOOKBLOCK DRIFT AT FULL DOWN POSITION (IN.) (X): 4-3/4				

HOIST NOTES:
 1. LARGER CONTROL BOXES MAY NEED TO BE RELOCATED
 2. PATENTED TRACK = 24-1/8"

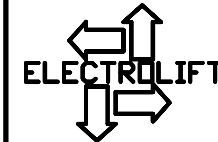

ELECTROLIFT, INC.
 204 SARGEANT AVE.
 CLIFTON, NJ 07013
 PH: 973-471-0204
 FAX: 973-471-2814
 www.electrolift.com

REV.	ECO#	DATE	BY:

HOIST TYPE: "B" SINGLE HOOK

CONFIGURATION: PLAIN TROLLEY

DATE:	SCALE:	DWG SIZE:	DRAWN BY:
6/22/04	1:12	B	AR

CATALOG NO.:	DRAWING NO.:
36-PL	B-132

CUSTOMER:

 REFERENCE NO.:

ELECTROLIFT AUTHORIZED DISTRIBUTOR: