

*ALLOW 6" CLEARANCE
TO SERVICE BRAKE

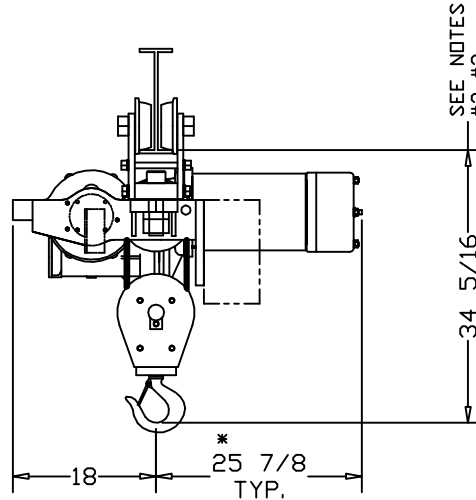

CATALOG #

	73-PL	-	-	-
SPEED (FPM):	15	-	-	-
LIFT (FT):	40	-	-	-

CAPACITY (LBS):	8000 LBS			
REEVING:	4 PART SINGLE			
PRIMARY VOLTAGE:	460 or 230 (3 PH. STD)			
CONTROL VOLTAGE:	115 (STD)			
HOIST WEIGHT (LBS):	1190			
HP:	6-1/2			

WHEEL LOADINGS (LBS PER WHEEL PAIR):			
FULL UP		FULL DOWN	
LEFT SIDE	RIGHT SIDE	LEFT SIDE	RIGHT SIDE
1846	3672	3014	3088

HOOKBLOCK DRIFT AT FULL DOWN POSITION (IN.) (X):	7-3/4
---	-------

- HOIST NOTES:
- LARGER CONTROL BOXES MAY NEED TO BE RELOCATED
 - TRACK WIDTH EXCEEDS 5-1/2" = 35-13/16"

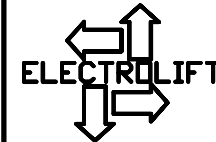

ELECTROLIFT, INC.
204 SARGEANT AVE.
CLIFTON, NJ 07013
PH: 973-471-0204
FAX: 973-471-2814
www.electrolift.com

REV.	ECO#	DATE	BY:

HOIST TYPE: "C" SINGLE HOOK

CONFIGURATION: PLAIN TROLLEY

DATE:	SCALE:	DWG SIZE:	DRAWN BY:
6/15/04	1:16	B	AR

CATALOG NO.:	DRAWING NO.:
73-PL	C-130

CUSTOMER:

REFERENCE NO.:

ELECTROLIFT AUTHORIZED DISTRIBUTOR: