

*ALLOW 6" CLEARANCE TO SERVICE BRAKE

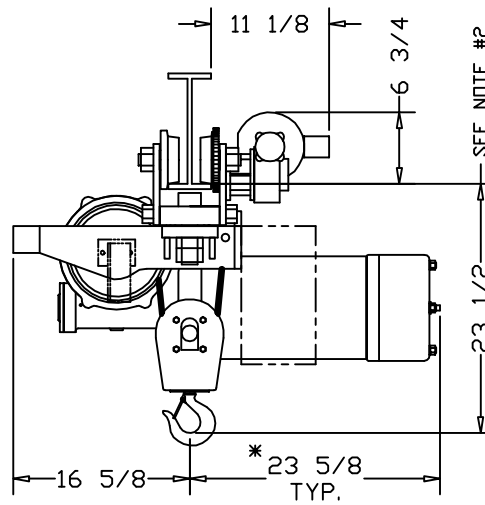

	CATALOG #			
	37-SD	-	-	-
SPEED (FPM):	25	-	-	-
LIFT (FT):	20	-	-	-
CAPACITY (LBS):	4000 LBS			
REEVING:	4 PART SINGLE			
PRIMARY VOLTAGE:	460 or 230 (3 PH. STD)			
CONTROL VOLTAGE:	115 (STD)			
HOIST WEIGHT (LBS):	570			
HP:	6-1/2			
WHEEL LOADINGS (LBS PER WHEEL PAIR):				
FULL UP		FULL DOWN		
LEFT SIDE	RIGHT SIDE	LEFT SIDE	RIGHT SIDE	
906	1832	1382	1594	
HOOKBLOCK DRIFT AT FULL DOWN POSITION (IN.) (X): 3-3/4				

HOIST NOTES:
 1. LARGER CONTROL BOXES MAY NEED TO BE RELOCATED
 2. PATENTED TRACK = 23 3/4"

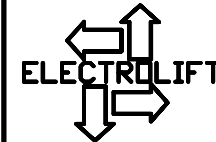

ELECTROLIFT, INC.
 204 SARGEANT AVE.
 CLIFTON, NJ 07013
 PH: 973-471-0204
 FAX: 973-471-2814
 www.electrolift.com

REV.	ECO#	DATE	BY:

HOIST TYPE: "B" SINGLE HOOK

CONFIGURATION: SIDE DRIVE TROLLEY

DATE:	SCALE:	DWG SIZE:	DRAWN BY:
7/13/04	1:12	B	AR
CATALOG NO.:		DRAWING NO.:	
37-SD		B-144	

CUSTOMER:

 REFERENCE NO.:

ELECTROLIFT AUTHORIZED DISTRIBUTOR: