

*ALLOW 6" CLEARANCE
TO SERVICE BRAKE

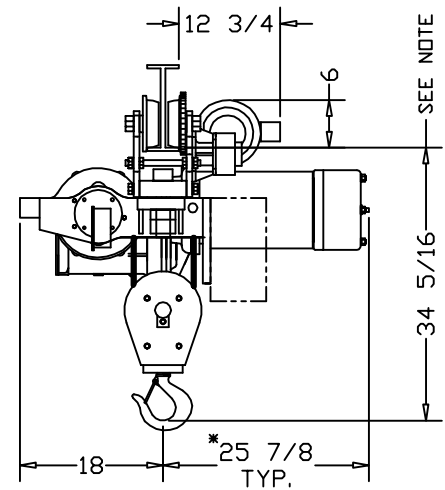

	CATALOG #			
	87-SD	-	-	-
SPEED (FPM):	10	-	-	-
LIFT (FT):	32	-	-	-
CAPACITY (LBS):	12000 LBS			
REEVING:	4 PART SINGLE			
PRIMARY VOLTAGE:	460 or 230 (3 PH. STD)			
CONTROL VOLTAGE:	115 (STD)			
HOIST WEIGHT (LBS):	1250			
HP:	6-1/2			
WHEEL LOADINGS (LBS PER WHEEL PAIR):				
FULL UP		FULL DOWN		
LEFT SIDE	RIGHT SIDE	LEFT SIDE	RIGHT SIDE	
2405	5393	4107	4510	
HOOKBLOCK DRIFT AT FULL DOWN POSITION (IN.) (X): 7-3/4				
HOIST NOTES:				
1. LARGER CONTROL BOXES MAY NEED TO BE RELOCATED				
2. TRACK WIDTH EXCEEDS 5-1/2" = 35-13/16"				

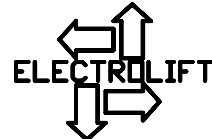

ELECTROLIFT, INC.
204 SARGEANT AVE.
CLIFTON, NJ 07013
PH: 973-471-0204
FAX: 973-471-2814
www.electrolift.com

REV.	ECO#	DATE	BY:
HOIST TYPE: "C" SINGLE HOOK			
CONFIGURATION: SIDE DRIVE TROLLEY			
DATE:	SCALE:	DWG SIZE:	DRAWN BY:
7/15/04	1:16	B	AR
CATALOG NO:		DRAWING NO:	
87-SD		C-149	

CUSTOMER:

REFERENCE NO.:

ELECTROLIFT AUTHORIZED DISTRIBUTOR: