

\*ALLOW 6" CLEARANCE TO SERVICE BRAKE

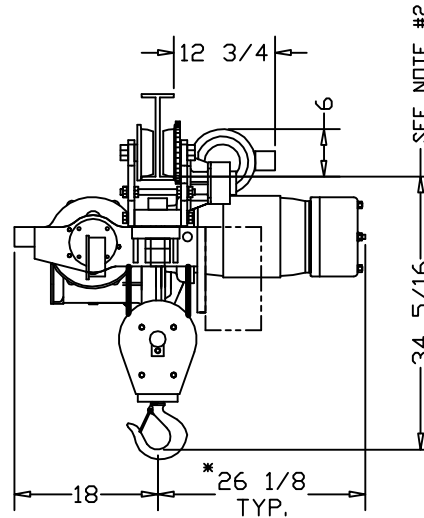

	CATALOG #			
	92-SD	-	-	-
SPEED (FPM):	10	-	-	-
LIFT (FT):	32	-	-	-
CAPACITY (LBS):		15000 LBS		
REEVING:		4 PART SINGLE		
PRIMARY VOLTAGE:		460 or 230 (3 PH. STD)		
CONTROL VOLTAGE:		115 (STD)		
HOIST WEIGHT (LBS):		1350		
HP:		7-1/2		
WHEEL LOADINGS (LBS PER WHEEL PAIR):				
		FULL UP		FULL DOWN
LEFT SIDE	RIGHT SIDE	LEFT SIDE	RIGHT SIDE	
2901	6725	5108	5621	
HOOKBLOCK DRIFT AT FULL DOWN POSITION (IN.) (X): 7-3/4				
HOIST NOTES:				
1. LARGER CONTROL BOXES MAY NEED TO BE RELOCATED				
2. TRACK WIDTH EXCEEDS 5-1/2" = 35-13/16"				

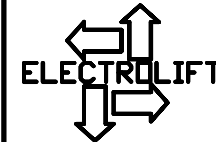

ELECTROLIFT, INC.  
 204 SARGEANT AVE.  
 CLIFTON, NJ 07013  
 PH: 973-471-0204  
 FAX: 973-471-2814  
 www.electrolift.com

REV.	ECO#	DATE	BY:
HOIST TYPE: "C" SINGLE HOOK			
CONFIGURATION: SIDE DRIVE TROLLEY			
DATE:	SCALE:	DWG SIZE:	DRAWN BY:
7/15/04	1:16	B	AR
CATALOG NO:		DRAWING NO:	
92-SD		C-150	

CUSTOMER:  
  
 REFERENCE NO.:

ELECTROLIFT AUTHORIZED DISTRIBUTOR: