

*ALLOW 6" CLEARANCE TO SERVICE BRAKE

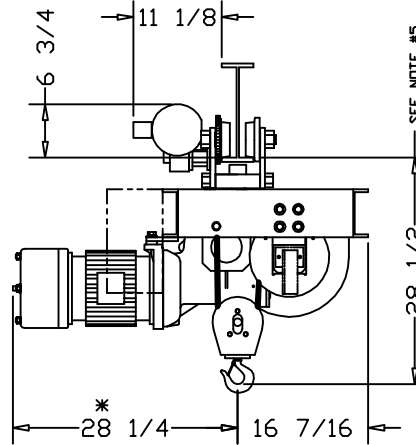

CATALOG #	SPEED (FPM):	LIFT (FT):
169-SD	14	20
199-SD	14	40
863-SD	14	50
-	-	-
-	-	-
-	-	-

CAPACITY (LBS):	6000 LBS
REEVING:	2 PART SINGLE
PRIMARY VOLTAGE:	460 or 230 (3 PH. STD)
CONTROL VOLTAGE:	115 (STD)
HOIST WEIGHT (LBS):	1050
HP:	4
WHEEL LOADINGS (LBS PER WHEEL PAIR):	
LEFT SIDE:	1763
RIGHT SIDE:	3525

- HOIST NOTES:
1. SPECIFIC CONTROL BOX LOCATION WILL BE DEFINED UPON CONTROLS SELECTION, HOOK CENTERS, AND APPLICATION SPECIFIC CLEARANCE ISSUES
 2. AS SHOWN, CONFIGURATION IS ACCEPTABLE FOR HOOK CENTERS UP TO 120"
 3. CHANNEL GAUGE MAY INCREASE AS HOOK CENTERS BECOME LARGER
 4. CONTACT FACTORY FOR APPLICATIONS THAT REQUIRE HOOK CENTERS LARGER THAN 120"
 5. S6 TRACK = 28-3/4"

ELECTROLIFT

ELECTROLIFT, INC.
204 SARGEANT AVE.
CLIFTON, NJ 07013
PH: 973-471-0204
FAX: 973-471-2814
www.electrolift.com

REV.	ECO#	DATE	BY:
------	------	------	-----

HOIST TYPE: "BC-4P" TWIN HOOK

CONFIGURATION: SIDE DRIVE TROLLEY

DATE:	SCALE:	DWG SIZE:	DRAWN BY:
8/13/04	1:16	B	AR

CATALOG NO.:	DRAWING NO.:
169-SD 199-SD 863-SD	BC-120

CUSTOMER:

REFERENCE NO.:

ELECTROLIFT AUTHORIZED DISTRIBUTOR: