

HOIST MOUNTING DETAIL
HOLE LOCATIONS

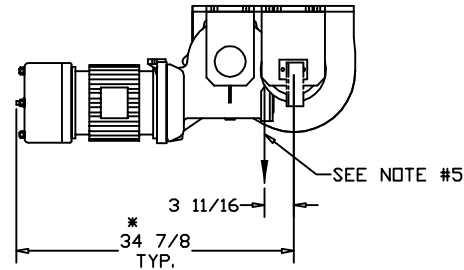

*ALLOW 6" CLEARANCE TO SERVICE BRAKE

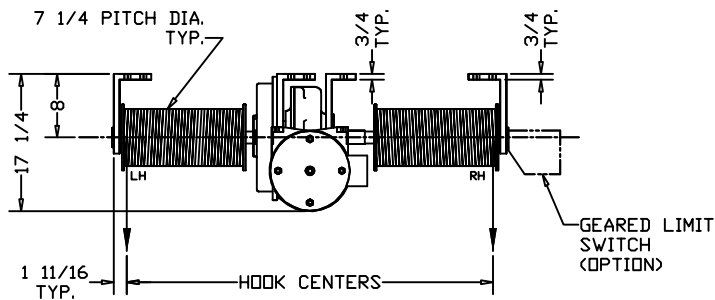
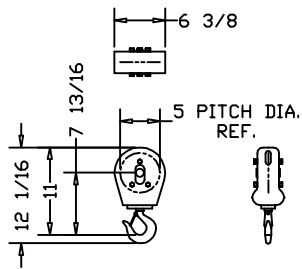

M-1046-A HOOK BLOCK
3000 LB. CAPACITY
5" PITCH DIA.
(2) SUPPLIED PER HOIST STD.
SHIPPED LOOSE

CUSTOMER:

REFERENCE NO.:

ELECTROLIFT AUTHORIZED DISTRIBUTOR:

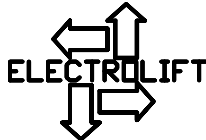
		CATALOG #			
		283-OH	-	-	-
SPEED (FPM):	14	-	-	-	
HP:	4	-	-	-	
MAX. HOOK CENTERS (IN.): (SEE NOTE #4)	46	-	-	-	
LIFT (FT.):	40				
CAPACITY (LBS):	6000				
PRIMARY VOLTAGE:	460 or 230 (3 PH. STD)				
CONTROL VOLTAGE:	115 (STD)				
HOIST WEIGHT (LBS):	950				
REEVING:	2 PART SINGLE				
HOIST NOTES:					
1. STANDARD CONTROL BOX WILL BE SHIPPED LOOSE WITH HOIST, TO BE MOUNTED BY CUSTOMER.					
2. CONTROL BOX SIZE TO BE DETERMINED UPON CONTROLS SELECTION AT TIME OF ORDER.					
3. ALL ELECTRICAL CONNECTIONS BETWEEN HOIST AND CONTROL BOX TO BE COMPLETED BY CUSTOMER, UNLESS OTHERWISE SPECIFIED.					
4. FOR HOOK CENTERS LARGER THAN SPECIFIED MAXIMUM VALUE (SEE ABOVE), CONTACT ELECTROLIFT.					
5. WIRE ROPE CAN PAY OFF OPPOSITE SIDE OF DRUM, IF SPECIFIED.					
6. FOR SINGLE LINE APPLICATIONS, SPEED AND LIFT WILL BE TWICE THE SPECIFIED VALUE AND THE CAPACITY WILL BE HALF THE SPECIFIED VALUE.					
7. WIRE ROPE DEAD ENDING TO BE PROVIDED BY CUSTOMER					
		ELECTROLIFT, INC. 204 SARGEANT AVE. CLIFTON, NJ 07013 PH: 973-471-0204 FAX: 973-471-2814 www.electrolift.com			
REV.	ECO#	DATE	BY:		
HOIST TYPE:		"BC-4P" TWIN HOOK			
CONFIGURATION:		OVERHEAD MOUNTED			
DATE:	SCALE:	DWG SIZE:	DRAWN BY:		
8/30/04	1:16	B	AR		
CATALOG NO.:		DRAWING NO.:			
283-OH		BC-159			