

HOIST MOUNTING DETAIL HOLE LOCATIONS

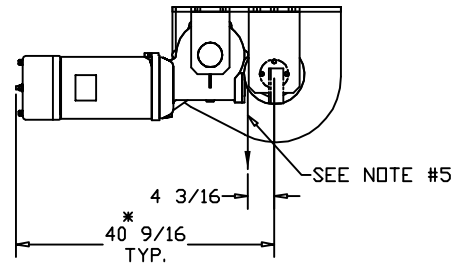

\*ALLOW 6" CLEARANCE TO SERVICE BRAKE

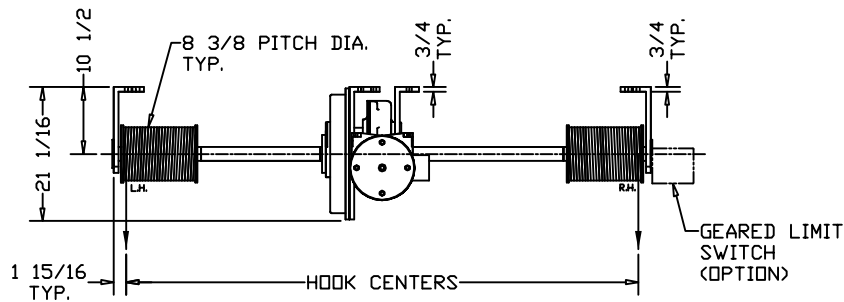
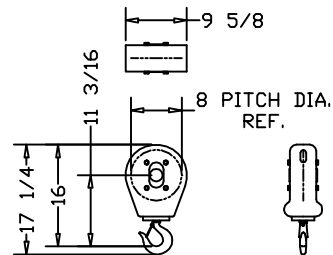

M-2538-A HOOK BLOCK  
6000 LB. CAPACITY  
8" PITCH DIA.  
(2) SUPPLIED PER HOIST STD.  
SHIPPED LOOSE

CUSTOMER:

ELECTROLIFT AUTHORIZED DISTRIBUTOR:

REFERENCE NO.:

CATALOG #

	288-OH	-	-	-
SPEED (FPM):	13	-	-	-
HP:	6-1/2	-	-	-
MAX. HOOK CENTERS (IN.): (SEE NOTE #4)	120	-	-	-
LIFT (FT.):	20			
CAPACITY (LBS):	10000			
PRIMARY VOLTAGE:	460 or 230 (3 PH. STD)			
CONTROL VOLTAGE:	115 (STD)			
HOIST WEIGHT (LBS):	1350			
REEVING:	2 PART SINGLE			
HOIST NOTES:	<ol style="list-style-type: none"> <li>STANDARD CONTROL BOX WILL BE SHIPPED LOOSE WITH HOIST, TO BE MOUNTED BY CUSTOMER.</li> <li>CONTROL BOX SIZE TO BE DETERMINED UPON CONTROLS SELECTION AT TIME OF ORDER.</li> <li>ALL ELECTRICAL CONNECTIONS BETWEEN HOIST AND CONTROL BOX TO BE COMPLETED BY CUSTOMER, UNLESS OTHERWISE SPECIFIED.</li> <li>FOR HOOK CENTERS LARGER THAN SPECIFIED MAXIMUM VALUE (SEE ABOVE), CONTACT ELECTROLIFT.</li> <li>WIRE ROPE CAN PAY OFF OPPOSITE SIDE OF DRUM, IF SPECIFIED.</li> <li>FOR SINGLE LINE APPLICATIONS, SPEED AND LIFT WILL BE TWICE THE SPECIFIED VALUE AND THE CAPACITY WILL BE HALF THE SPECIFIED VALUE.</li> <li>WIRE ROPE DEAD ENDING TO BE PROVIDED BY CUSTOMER</li> </ol>			

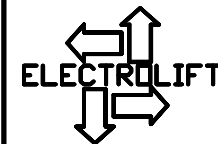

ELECTROLIFT, INC.  
204 SARGEANT AVE.  
CLIFTON, NJ 07013  
PH: 973-471-0204  
FAX: 973-471-2814  
www.electrolift.com

REV.	ECO#	DATE	BY:
HOIST TYPE:	"BC-3P" TWIN HOOK		
CONFIGURATION:	OVERHEAD MOUNTED		
DATE:	SCALE:	DWG SIZE:	DRAWN BY:
8/31/04	1:20	B	AR
CATALOG NO.:	DRAWING NO.:		
288-OH	BC-166		