

*ALLOW 6" CLEARANCE TO SERVICE BRAKE

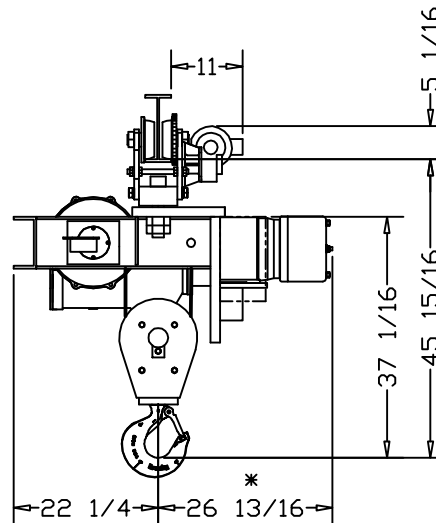
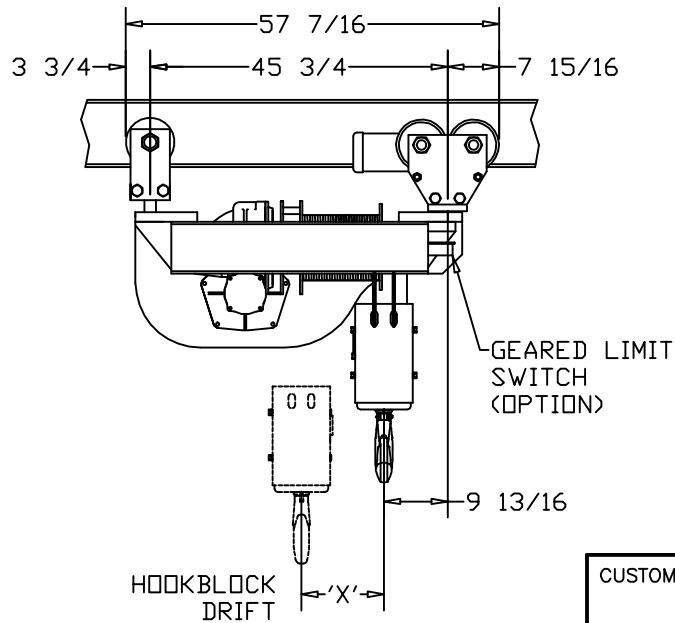

CUSTOMER:	ELECTROLIFT AUTHORIZED DISTRIBUTOR:
REFERENCE NO.:	

	CATALOG #			
	354-SD	-	-	-
SPEED (FPM):	15	-	-	-
LIFT (FT):	10	-	-	-
CAPACITY (LBS):	15000 LBS			
REEVING:	4 PART SINGLE			
PRIMARY VOLTAGE:	460 or 230 (3 PH. STD)			
CONTROL VOLTAGE:	115 (STD)			
HOIST WEIGHT (LBS):	1900			
HP:	10			
WHEEL LOADINGS (LBS PER WHEEL PAIR):				
FULL UP		FULL DOWN		
LEFT SIDE	RIGHT SIDE	LEFT SIDE	RIGHT SIDE	
4172	6364	5115	5892	
HOOKBLOCK DRIFT AT FULL DOWN POSITION (IN.) (X): 2-7/8				
HOIST NOTES: -LARGER CONTROL BOXES MAY NEED TO BE RELOCATED				
		ELECTROLIFT, INC. 204 SARGEANT AVE. CLIFTON, NJ 07013 PH: 973-471-0204 FAX: 973-471-2814 www.electrolift.com		
REV.	ECO#	DATE	BY:	
HOIST TYPE: "D" SINGLE HOOK				
CONFIGURATION: SIDE DRIVE TROLLEY				
DATE:	SCALE:	DWG SIZE:	DRAWN BY:	
6/30/14	1:20	B	AR	
CATALOG NO:		DRAWING NO:		
354-SD		D-168		